

# KÄRCHER

makes a difference

## B 60 W Bp

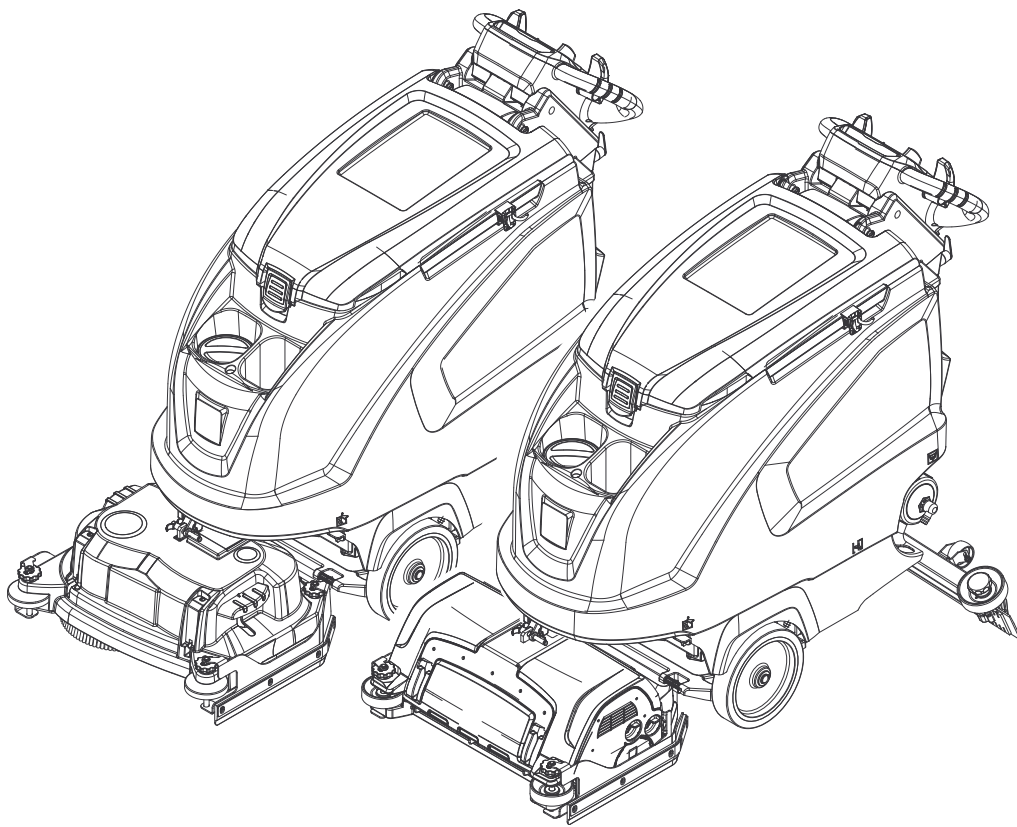

**Register and win!**  
[www.kaercher.com/register-and-win](http://www.kaercher.com/register-and-win)



001

**EAC**



59645740 07/17





Please read and comply with these original instructions prior to the initial operation of your appliance and store them for later use or subsequent owners.

## Contents

Safety instructions . . . . .	EN	1
Function . . . . .	EN	1
Proper use . . . . .	EN	1
Environmental protection . . . . .	EN	1
Warranty . . . . .	EN	1
Operating and Functional Elements . . . . .	EN	2
Before Startup . . . . .	EN	3
Operation . . . . .	EN	4
Shutting Down the Appliance . . . . .	EN	5
Grey Intelligent Key . . . . .	EN	5
Transport . . . . .	EN	5
Storage . . . . .	EN	5
Care and maintenance . . . . .	EN	5
Frost protection . . . . .	EN	8
Faults . . . . .	EN	9
Accessory B 60 . . . . .	EN	10
Technical specifications . . . . .	EN	11
EU Declaration of Conformity . . . . .	EN	11
Accessories and Spare Parts . . . . .	EN	11

## Safety instructions

Before using the appliance for the first time, read and observe these operating instructions and the accompanying brochure: Safety information for brush cleaning units and spray-extraction units, No. 5.956-251.0.

**The appliance may only be operated when the hood and all lids are closed. Remove the Intelligent Key (emergency stop) to take all functions out of operation immediately.**

*The appliance must only be operated on surfaces that do not exceed the max. permitted incline (see "Technical Specifications").*

### **⚠ WARNING**

*Do not use the appliance on inclines.*

### Safety Devices

Safety devices serve to protect the user and must not be rendered in operational or their functions bypassed.

### Driving lever

If the drive lever is released, the travel drive and the brush drive shuts off.

### Hazard levels

#### **⚠ DANGER**

*Pointer to immediate danger, which leads to severe injuries or death.*

#### **⚠ WARNING**

*Pointer to a possibly dangerous situation, which can lead to severe injuries or death.*

#### **⚠ CAUTION**

*Pointer to a possibly dangerous situation, which can lead to minor injuries.*

#### **ATTENTION**

*Pointer to a possibly dangerous situation, which can lead to property damage.*

## Function

The scrubber vacuum is used for wet cleaning or polishing of level floors.

- You can adjust the machine to suit the cleaning task by modifying the settings for water quantity, contact pressure of the brushes, detergent quantity and driving speed.
- The appliance is equipped with a fresh water and a wastewater reservoir (60 litres each). These allow an effective cleaning with a long usage life.
- Depending on the selected cleaning head, the working width is between 550 mm and 650 mm.
- This appliance model is equipped with a travel drive. The travel speed can be adjusted with a rotary knob.
- A charger is already integrated in all models. Batteries can be selected according to the configuration (see Chapter "Recommended batteries")

### Note:

The appliance can be equipped with various accessories depending on the cleaning task.

Please request our catalogue or visit us on the Internet at [www.kaercher.com](http://www.kaercher.com).

## Proper use

Use this appliance only as directed in these operating instructions.

- The appliance may only be used for the cleaning of hard surfaces that are not sensitive to moisture and polishing operations.
- The appliance is not suited for the cleaning of frozen grounds (e.g. in cold stores).
- The appliance may only be equipped with original accessories and spare parts.
- The appliance is not suited for the use in potentially explosive environments.
- The machine should not be used to suck in inflammable gases, undiluted acids or solvents. This includes petrol, thinning agents or hot oil that can form an explosive mixture when it comes in contact with sucked air. Do not use acetone, undiluted acids and solvents as they are aggressive towards the materials from which the appliance is made.
- The machine has been approved for use on surfaces with max. gradients as listed under "Technical Specifications".

## Environmental protection



The packaging materials are recyclable. Please do not throw packaging in the domestic waste but pass it on for recycling.



Old units contain valuable recyclable materials. Batteries, oil and similar substances may not be released into the environment. Therefore please dispose of old units through suitable collection systems.

### Notes about the ingredients (REACH)

You will find current information about the ingredients at:

[www.kaercher.com/REACH](http://www.kaercher.com/REACH)

## Warranty

The warranty terms published by our competent sales company are applicable in each country. We will repair potential failures of your accessory within the warranty period free of charge, provided that such failure is caused by faulty material or defects in fabrication. In the event of a warranty claim please contact your dealer or the nearest authorized Customer Service center. Please submit the proof of purchase.

# Operating and Functional Elements

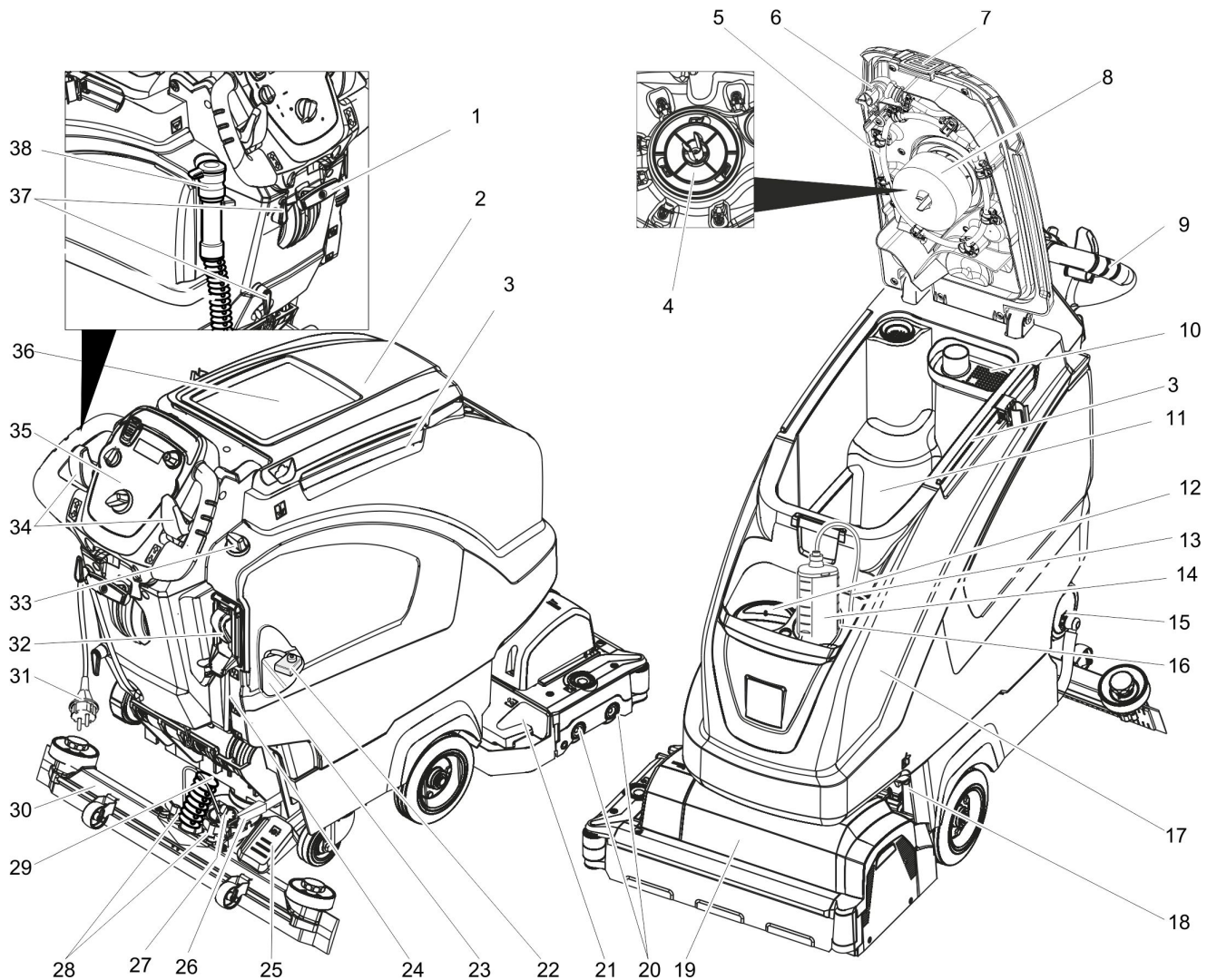

- |   |   |
|---|---|
| 1 Vacuum bar lowering lever                           | 24 Fresh water level display                        |
| 2 Cover waste water tank                              | 25 Pedal for raising/ lowering the cleaning head    |
| 3 Holding rail for home base                          | 26 Lever to adjust the brush contact pressure       |
| 4 Protective turbine strainer (under the float)       | 27 Rotary handle to incline the vacuum bar          |
| 5 Wastewater reservoir rinsing system (option)        | 28 Wing nuts for fastening the vacuum bar           |
| 6 Flexible lock of rinsing system (option)            | 29 Suction hose                                     |
| 7 Lock of waste water tank                            | 30 Vacuum bar *                                     |
| 8 Float   | 31 Connecting cable for charger                     |
| 9 Push handle   | 32 Automatic fill of fresh water reservoir (option) |
| 10 Coarse dirt sieve                                  | 33 Water quantity regulator                         |
| 11 Waste water tank                                   | 34 Driving lever                                    |
| 12 Fresh water reservoir filler neck                  | 35 Operator console                                 |
| 13 Suction hose for detergent (only DOSE model)       | 36 Storage surface for cleaning set "Home base box" |
| 14 Detergent bottle (only DOSE model)                 | 37 Cable hook                                       |
| 15 Lock of the fresh water reservoir with filter      | 38 Drain hose for wastewater with dosing unit       |
| 16 Detergent bottle holder                            |   |
| 17 Fresh water tank                                   |   |
| 18 Locking the tank                                   |   |
| 19 Cleaning head (illustration is symbolic) *         |   |
| 20 Brush rollers (BR model) Disk brushes (BD model) * |   |
| 21 Waste container (only BR)                          |   |
| 22 Battery pole fuse                                  |   |
| 23 Battery *  |   |

\* not included in the delivery

### Colour coding

- The operating elements for the cleaning process are yellow.
- The controls for the maintenance and service are light gray.

### Operator console

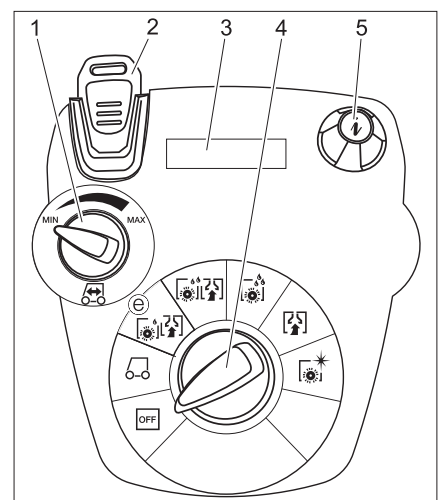

- 1 Rotating button for drive speed
- 2 Intelligent Key  
yellow - operator  
grey - supervisor
- 3 Display
- 4 Program selection switch
- 5 Info button



## Program selection switch

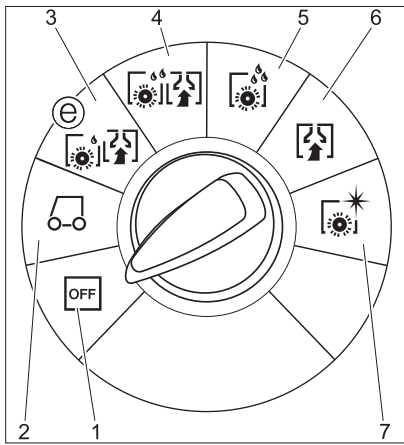

- 1 **OFF**  
Device is switched off
- 2 **Transport mode**  
Driving to the Place of Use.
- 3 **Ecoefficiency mode**  
Wet clean the floor (with reduced brush speed) and vacuum up wastewater (with reduced suction).
- 4 **Normal mode**  
Wet clean the floor and vacuum up dirt water.
- 5 **Intense mode**  
Wet clean the floor and allow the detergent to react.
- 6 **Vacuum mode**  
Suck in the dirt fleet.
- 7 **Polishing mode**  
Polishing the floor without the application of liquid.

## Before Startup

### Installing the Brushes

#### BD model

The disc brush must be installed before the initial operation (see "Maintenance work").

#### BR model

The brushes are mounted.

### Install batteries

Install the batteries (see "Care and Maintenance/Install and connect batteries").

### Setting the charging marker line

Prior to the initial startup, following a service reset or when switching to another battery type, you must adjust the charging marker line.

- Use the Grey Intelligent Key.
- Setting the charging marker line (see Chapter "Grey Intelligent Key/Setting the charging marker line".

### Using batteries made by other manufacturers

We recommend using our batteries as described in chapter "Care and Maintenance/Recommended batteries".

#### Note:

When using other batteries (e.g. batteries from other manufacturers), the total discharge protection level for the respective battery must be reset by the Kärcher after-sales service.

## Charging battery

#### Note:

The device is equipped with a safety mechanism to prevent total discharge, i.e. when the permissible minimum capacity is reached, the brush motor and the turbine are switched off.

- Drive the machine directly to the charging station; avoid any steep gradients in the process.

#### ⚠ DANGER

*Danger of injury due to electric shock. Observe the mains voltage and fuse protection on the type plate of the device.*

*Only use the charger in dry rooms with sufficient ventilation!*

### Charging process

- Average charging time is approx. 10 -15 hours.
- The built-in charger has electronic controls and is suitable for all recommended batteries; it automatically switches off the charging process.
- The built-in battery is shown on the display during the charging process. If this is not the case, the charging marker line must be selected (see "Setting the charging marker line").
- The appliance must not be used during the charging process.

#### ⚠ DANGER

*Risk of explosion!*

*Prior to **Charging low-maintenance batteries**, the tank must be swivelled upwards (see chapter "Installing and connecting batteries"). This will prevent the generation of dangerous gases during the charging process under the tank.*

*While the water tank is folded up, you must not clean with any water.*

*When **charging maintenance-free batteries**, the water tank does not need to be folded up.*

- Insert the plug of the connecting cable into the socket. The charging process will start.

**Note:** The selected battery will be displayed during charging.

- Charge until the display shows a full charge.

### Information on the initial charge

With the initial charge, the control will not yet be able to detect which battery type has been installed. Keep charging the batteries until the display shows a full charge (batteries may still not be completely charged).

The next charging process will have an accurate display and charge power and the batteries will be fully charged.

Use the appliance until the deep discharge protection switches off the brush motor and the turbine after the initial charge of the battery. This procedure is necessary to adjust the battery indicator. Only then the correct battery status is displayed.

### Low maintenance batteries (wet batteries)

#### ⚠ WARNING

*Danger of causticization!*

- *Adding water to the battery in its discharged state can cause the acid to leak.*

- *Use safety glasses while handling battery acid and follow the safety instructions to avoid personal injury or damage to clothes.*
- *Should the acid spray on to the skin or clothes, rinse immediately with lots of water.*

#### ATTENTION

*Risk of damage!*

- *Use only distilled or desalinated water (EN 50272-T3) for filling the battery.*
- *Do not add any substances (so-called performance improving agents), else warranty claims will not be entertained.*
- *Replace batteries with the same battery type only. Otherwise the charging characteristic must be readjusted by the after-sales service.*

## Installing the Vacuum Bar

- Insert the vacuum bar into the vacuum bar suspension in such a manner that the profiled sheet is positioned above the suspension.
- Tighten the wing nuts.

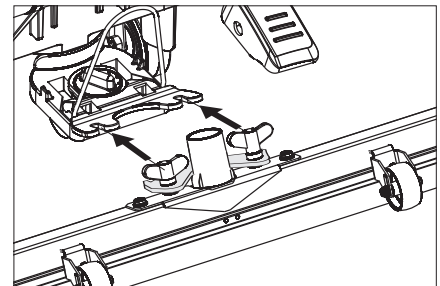

- Insert the suction hose.

## Unloading

#### ⚠ DANGER

*Risk of injury. Pull the Intelligent Key to take all functions out of operation immediately.*

- Install the batteries and connect them (see "Care and Maintenance/Install and connect batteries").
- Place long lateral boards of the packaging as a ramp next to the pallet.

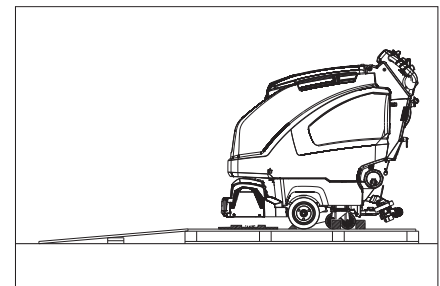

- Fix the ramp on the pallet with nails.
- Place short boards as a support underneath the ramp.
- Remove the wooden bars in front of the wheels.
- Lift the cleaning head by pressing the pedal all the way down. Remove the cardboard with the R cleaning head.
- Plug in the Intelligent Key.
- Turn the program selection switch to transport mode.
- Press the driving lever and slowly move the machine down from the ramp.
- Remove the Intelligent Key.

## Operation

### ⚠ DANGER

*Risk of injury. Push the pedal for raising/lowering the cleaning head with one foot only. The other foot must firmly be placed on the floor.*

*In dangerous situations, release the safety switch/drive lever.*

### Driving

#### ATTENTION

*Risk of damage. The suction bar must be lifted for reversing.*

#### Note:

The device is designed and built in such a way that the cleaning head protrudes towards the right. This enables working in a comfortable way close to the edges.

- ➔ Plug in the Intelligent Key.
- ➔ Preselect the speed on the drive speed rotary knob.
- ➔ Turn the programme selection switch to transport mode.
- ➔ Drive the machine.
  - Forwards: Press the driving lever to the front.
  - Backward: Press the driving lever to the rear.

#### Note:

The device moves only when the driving lever is moved by 15°.

- ➔ Stop the machine: Release driving lever.

### Filling in detergents

#### Fresh water

- ➔ Open the lock of the fresh water reservoir.
- ➔ Fill fresh water (maximum 60 °C) until the lower edge of the filling nozzle.
- ➔ Close the lock of the fresh water reservoir.

#### With automatic fill of fresh water reservoir (option)

- ➔ Connect the hose to the automatic filling system and open the water supply (max. 60 °C, max. 5 bars).
- ➔ Monitor the appliance - the automatic filling system will interrupt the water supply when the tank is full.
- ➔ Shut off the water supply and disconnect the hose from the appliance.

#### Detergent

### ⚠ WARNING

*Risk of damage. Only use the recommended detergents. With other detergents, the operator bears the increased risk regarding the operational safety and danger of accident.*

*Only use detergents that are free from solvents, hydrochloric acid and hydrofluoric acid.*

*Follow the safety instructions for using detergents.*

#### Note:

Do not use highly foaming detergents.

#### Recommended detergents:

Application	Detergent
Routine cleaning of all water resistant floors	RM 746 RM 780

Routine cleaning of glossy surfaces (e.g. granite)	RM 755 es
Routine cleaning and basic cleaning of industrial floors	RM 69 ASF
Routine cleaning and basic cleaning of fine stoneware tiles	RM 753
Routine cleaning of tiles in sanitary areas	RM 751
Cleaning and disinfection in sanitary areas	RM 732
Removal of coating from all alkali-resistant floors (e.g. PVC)	RM 752
Removal of coating from lithium floors	RM 754

#### Appliance with dosing equipment DOSE (option)

Detergent is added to the fresh water on the way to the cleaning head with the help of a dosaging device.

#### Note:

The dosing unit can be used to add 3% detergent at maximum. With higher dosage the detergent must be put into the fresh water tank.

- ➔ Place the detergent bottle into the holder.
- ➔ Close the bottle lid.
- ➔ Insert the suction hose of the dosaging equipment into the bottle.

#### Note:

If the fresh water tank is empty, then the function of adding detergent gets deactivated. The cleaning head continues to work without the addition of any liquid.

#### Models without dosing equipment

- ➔ Add the detergent to the fresh water reservoir.

### Setting the water quantity

- ➔ Adjust the water quantity using the regulating button according to the dirt on the floor covering.

#### Note:

Carry out initial cleaning attempts with low water volume. Increase water volume step-by-step until the desired cleaning result is achieved.

The detergent pump of the dosing equipment does not start working until a minimum water volume is present.

### Setting the Vacuum Bar

#### Oblique position

To improve the vacuuming result on tiled floors the vacuum bar can be turned to an oblique position of up to 5°.

- ➔ Loosen the wing nuts.
- ➔ Turn the vacuum bar.

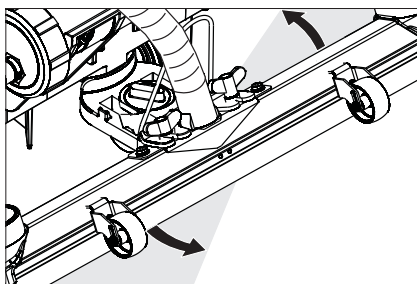

- ➔ Tighten the wing screws.

### Inclination

If the vacuum result is unsatisfactory the inclination of the straight vacuum bar can be modified.

- ➔ Adjust the rotary handle to incline the suction bar.

### Setting the parameters

#### With yellow Intelligent Key

Parameters for the different cleaning programmes are preset in the appliance. Depending on the authorisation of the yellow Intelligent Key, individual parameters can be changed.

If you wish to permanently change the parameters, you must use a grey Intelligent Key. This adjustment procedure is described in the section "Grey Intelligent Key".

#### Note:

Almost all displayed text regarding parameter adjustment is self-explanatory. The only exception is the parameter FACT:

- Fine Clean: Lower brush speed for removing the grey film on fine stone floors.
  - Whisper Clean: Medium brush speed for regular cleaning with reduced noise level.
  - Power Clean: High brush speed for polishing, crystallising and sweeping.
- ➔ Turn the program selection switch to the desired cleaning program.
  - ➔ Turn the info button until the desired parameter is displayed.
  - ➔ Press Info button - the set value blinks.
  - ➔ Set the desired value by turning the info button.
  - ➔ Confirm the changed setting by pressing the Info button or wait till the set value is automatically accepted after 10 seconds.

### Cleaning

#### ATTENTION

*Risk of damage to the floor covering. Do not operate the appliance on the spot.*

- ➔ Turn the program selection switch to the desired cleaning program.

#### Lower the cleaning head

- ➔ Press the pedal for lowering the cleaning head downwards slightly and then move it to the left. This unlocks the pedal. Release the pedal slowly upwards. The cleaning head is lowered.

#### Note:

The brush motor comes to a halt when the machine stops and when there is overload.

#### Adjusting the brush contact pressure

- ➔ Arrest the lever in the desired position.
  - Upper position: higher contact pressure
  - Lower position: reduced contact pressure

#### Lower the vacuum bar

- ➔ Pull the lever out and press it down; the vacuum bar is lowered.

#### Note:

- For cleaning tiled floors, adjust the straight suction bar in such a way that

cleaning is not done at an angle of 90 degrees to the joints.

- The inclined position and the inclination of the suction bar can be adjusted to achieve better suction results (see "Adjusting the suction bar").
- **If the wastewater reservoir is full**, the floater will close the suction opening and the suction turbine will run at a higher speed. If this is the case, shut the vacuum off and drive to empty the wastewater reservoir.

### Shutting Down the Appliance

- Close the regulatory button for setting the water quantity.
- Release drive lever/safety switch.
- Set the program selection switch to suction or vacuuming.
- Lift the cleaning head.
- Briefly drive forward and suck of the remaining water.
- Raise the vacuum bar.  
The suction turbine will continue to run for 10 more seconds to suck off residual water from the vacuum bar and the vacuum hose.
- Remove the Intelligent Key.
- Charge battery, if required.

### Drain off dirt water

#### ⚠ WARNING

Please observe the local provisions regarding the wastewater treatment.

- Take the water discharge hose from the support and lower above a suited collection device.

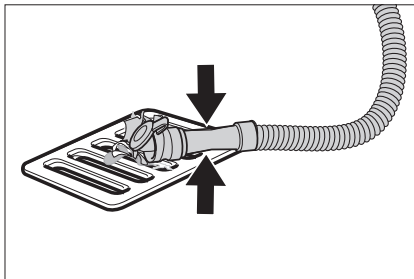

- Crush or bend the dosing equipment.
- Open the lid of the dosing equipment.
- Drain off the dirt water - regulate the water quantity by pressing or bending.
- Rinse the waste water tank with clean water or with the rinsing system for the waste water tank (option).

### Drain off clean water

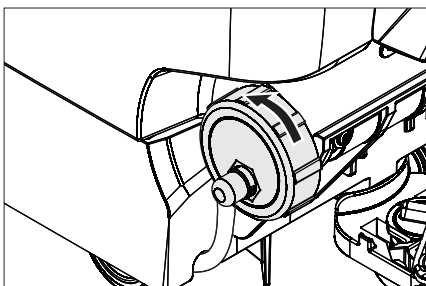

- Loosen the lid for emptying the fresh water slowly - do not remove it fully.

For a quicker emptying process, remove the entire lid.

- To rinse the fresh water reservoir, remove the cover completely and remove the fresh water filter.

### Grey Intelligent Key

- Plug in the Intelligent Key.
- Select the desired function by turning the Info button.

The different functions are described in the following.

#### Key menu >>

In this menu item, the authorisations for the yellow Intelligent Keys are released.

- Press the info button while "Key menu >>" is displayed.
- Remove the grey Intelligent Key and insert the yellow Intelligent Key to be programmed.
- Select the desired menu item to be modified by turning the Info button.
- Press Info button.
- Adjust the menu item by turning the Info button.
- Confirm the setting by pressing the menu item.
- Select the next menu item to be modified by turning the Info button.
- To save the authorisations, retrieve the menu "Save settings" by turning the info button and pressing it.
- To exit, retrieve the menu "Exit menu" by turning the info button and pressing it.

#### Cleaning App >>

Parameters that are adjusted with the grey Intelligent Key, are kept until another setting is selected.

- Turn the program selection switch to the desired cleaning program.
- Turn the info button until "Cleaning App >>" is displayed.
- Press the info button - the first adjustable parameter is displayed.
- Press Info button - the set value blinks.
- Set the desired value by turning the info button.
- Confirm the changed setting by pressing the Info button or wait till the set value is automatically accepted after 10 seconds.
- Select the next parameter by turning the Info button.
- After all desired parameters have been modified, turn the info button until "Exit menu" is displayed.
- Press the info button - you will exit the menu.

#### Setting the language

- Press Info button - the set value blinks.
- Set the desired language by turning the info button.
- Confirm the changed setting by pressing the Info button or wait till the set value is automatically accepted after 10 seconds.

### Brush trailing

Adjust the trailing time of the brushes.

- Same adjustment as "Set language".

### Setting the charging marker line

- Turn the info button until the function "Battery menu" is displayed.
- Press the info button - select the charging marker line according to the built-in batteries.

**Note:** Setting the charging marker line should be discussed with Kärcher customer service. This applies especially if the battery is not listed in the menu.

- Confirm the changed setting by pressing the Info button or wait till the set value is automatically accepted after 10 seconds.

### LOAD DEFAULT

Recreate the basic settings.

### Transport

#### ⚠ DANGER

Risk of injury! When loading or unloading the machine, it may only be operated on gradients up to the maximum value (see "Technical Specifications"). Drive slowly.

#### ⚠ CAUTION

Risk of personal injury or damage! Mind the weight of the appliance during transport.

- Raise the cleaning head to avoid damage to the brushes.
- Remove the brush to avoid damage to the brushes.

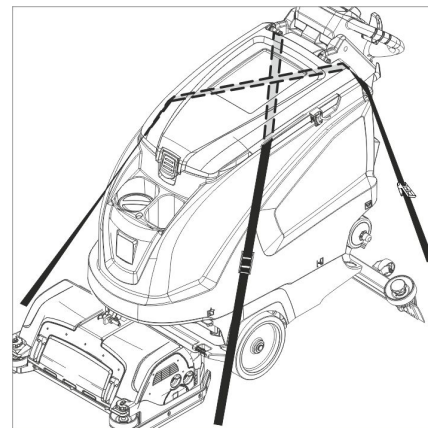

- When transporting in vehicles, secure the appliance according to the guidelines from slipping and tipping over.

### Storage

#### ⚠ CAUTION

Risk of personal injury or damage! Consider the weight of the appliance when storing it.

This appliance must only be stored in interior rooms.

### Care and maintenance

#### ⚠ DANGER

Risk of injury! Before working on the appliance, remove the Intelligent Key and the mains plug of the charger.

- Drain and dispose of the dirt water and the residual fresh water.



## Maintenance schedule

### Maintenance intervals

Recommended cleaning processes are shown on the display at certain cleaning intervals.

- Perform the maintenance task shown on the display.
- Press the Info Button, the display will be reset. The display will be shown again at certain predefined time intervals.

Display	Display all
Clean the vacuum bar	20 hours
Clean the fluff filter	20 hours
Clean water filter.	50 hours
Check the suction lips	100 hours
Check the brushes	100 hours
Service reset	200 hours

**Note:** A service reset resets all maintenance intervals.

### After each operation

#### ATTENTION

*Risk of damage. Do not sluice the appliance with water and do not use aggressive detergents.*

- Drain off dirt water.
- Rinse the waste water tank with clean water or with the rinsing system for the waste water tank (option).
- Remove the coarse dirt sieve from the waste water tank and clean it.
- Clean the outside of the appliance with a damp cloth which has been soaked in mild detergent.
- Clean protective turbine strainer.
- Only BR model: Remove bulk waste container and empty it.
- Only BR model: Clean water distributor channel (see section „Maintenance work“).
- Clean the vacuum lips and the wiping lips, check for wear and replace if required.
- Check the brushes for wear, replace if required.
- Press the lock of the waste water tank in and close the cover of the waste water tank so that a gap remains open to facilitate drying.

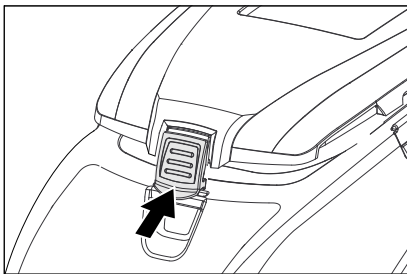

- Charge the battery:  
If the charging state of the battery is under 50%, charge the battery fully and without interruption.  
If the charging state of the battery is over 50%, only recharge the battery if the entire operation duration will be required when next used.

### Weekly

- When used regularly, charge the battery fully and without interruption at least once a week.

### Monthly

- Check battery poles for oxidation, brush off if necessary. Ensure that the connection cable sits firmly.
- Clean the seals between waste water tank and cover and check for tightness, replace if required.
- Check the acid density of the cells if the batteries are not maintenance-free batteries.
- Clean the brush tunnel (only BR model).
- For long periods of disuse, only turn the device off when the battery is fully charged. Fully recharge the battery at least every month.

### Yearly

- Have the prescribed inspection carried out by the customer service.

## Maintenance Works

### Cleaning the protective turbine strainer

- Open the cover of the waste water tank.

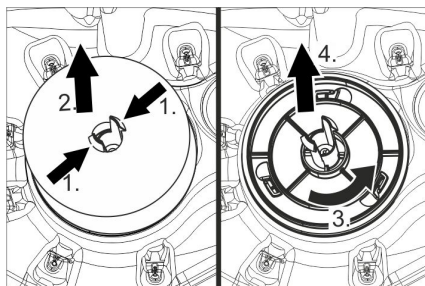

- Squeeze the locking hooks.
- Pull off the float.
- Turn the protective turbine strainer in a counter-clockwise direction.
- Remove protective turbine strainer.
- Rinse dirt off the protective turbine strainer with water.
- Reattach protective turbine strainer.
- Attach float.

### Waste water tank rinsing system (option)

- Drain the wastewater, see section "Drain wastewater".
- Open the cover of the waste water tank.
- Pull the flexible lock off of the rinsing system.
- Connect the water hose to the rinsing system.

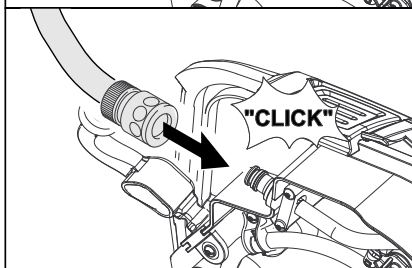
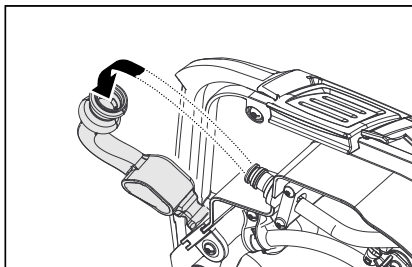

- Close the cover of the wastewater reservoir until it rests on the flexible lock.
- Open the water supply and rinse the wastewater reservoir for about 30 seconds.  
Repeat the rinsing process 2 to 3 times.
- Shut off the water supply and disconnect the hose from the appliance.
- Reattach the flexible lock to the connection. Leave the wastewater reservoir cover open a crack to let it dry.

### Replace or turn vacuum lips

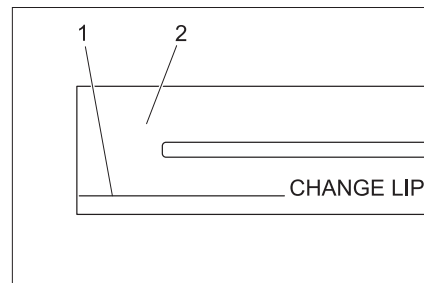

- 1 Wear indicator
- 2 Vacuum lip

The vacuum lips must be replaced or reversed if they are worn down to the wear indicator.

- Remove the vacuum bar.
- Unscrew the star grips.

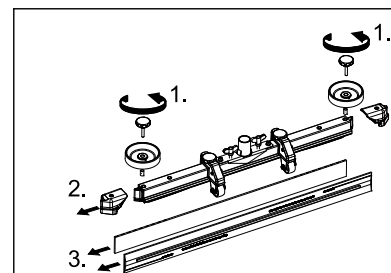

- Remove the plastic parts.
- Remove the vacuum lips.
- Insert new or reversed vacuum lips.
- Insert the plastic parts.
- Screw in and tighten the star grips.

### Clean water distribution channel

- Remove the rubber strip and clean the channel with a cloth. After cleaning, replace the rubber strip evenly.

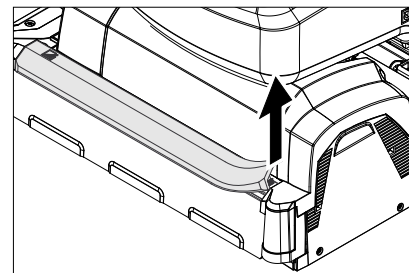



## Replacing the brush rollers

- Lift the cleaning head.

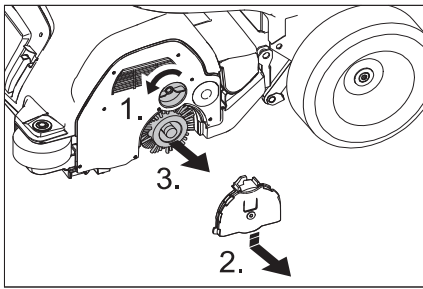

- Loosen the lock of the wiper flap.
  - Push the bearing lid down and remove.
  - Pull out the brush roller.
- Note:** The brush rollers must be replaced when the bristle length has reached 10 mm.
- Insert a new brush roller.
  - Reassemble the bearing lid in the reverse sequence.
  - Repeat process on the opposite side.

## Replacing the disk brushes

- Lift the cleaning head.
- Press the pedal for changing the brushes downward beyond its resistance.

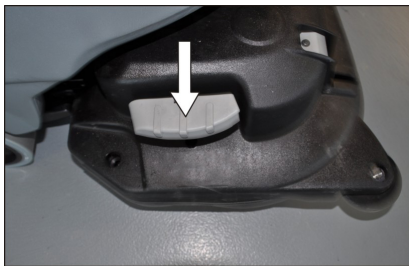

- Pull the disc brush out of the side below the cleaning head.
- Hold the new disc brush under the cleaning head, push upward and lock.

## Install cleaning head

- Push the appliance forward about 2 m so that the steering rollers point toward the rear.
- Press the pedal for lowering the cleaning head downwards slightly and then move it to the left. This unlocks the pedal. Release the pedal slowly upwards. The lift arm of the cleaning head will be lowered.

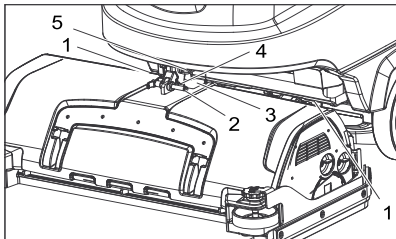

- 1 Spring element
- 2 Locking pin
- 3 Terminal strip cover
- 4 Lock of safety pin
- 5 Excenter lever

- Remove the terminal strip cover.
- Place the cleaning head halfway in front of the appliance.

- Connect the mains supply cable of the cleaning head to the appliance.
- Attach the terminal strip cover.
- Connect the hose couplers on the cleaning head to the hose on the appliance.

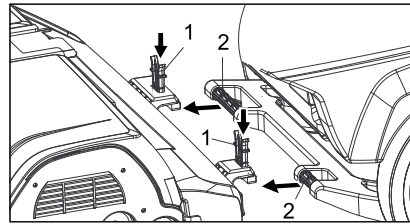

- 1 Spring element
- 2 Push handle

- Insert the push bow into the cleaning head intake.
- Push the spring elements down and lock them into place.

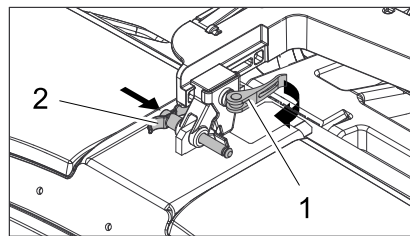

- 1 Excenter lever
- 2 Locking pin

- Open the excenter lever of the slideable intake on the lift arm.
- Press the cleaning head all the way against the push handle.

**Note:** The less play the cleaning head has after being installed, the less vibration will occur during cleaning.

- Move the intake and insert the safety pin and lock it into place.
- Close the excenter lever.
- Swivel the water reservoir all the way down, check the lock.

## Dismantling the cleaning head

The removal will take place in the opposite order of the installation.

### ⚠ CAUTION

When the cleaning head is removed, the stability of the appliance can be compromised; ensure a safe stance. Possibly support the rear to prevent tipping.

## Batteries

Please observe the following warning notes when handling batteries:

	Observe the directions on the battery, in the instructions for use and in the vehicle operating instructions
	Wear eye protection
	Keep children away from acid and batteries
	Danger of explosion

	Fire, sparks, naked flames and smoking must be strictly avoided
	Danger of chemical burns
	First aid
	Warning note
	Disposal
	Do not throw the battery into the regular waste

### ⚠ DANGER

Risk of explosion. Do not place tools or the like on the battery, i.e. on the terminal poles and cell connectors.

Risk of injury. Ensure that wounds never come into contact with lead. Always clean your hands after having worked with batteries.

## Recommended batteries, B 60

Order No.	Description	
6.654-141.0 <sup>1)</sup>	105 Ah - maintenance-free	12 V*
6.654-242.0 <sup>2)</sup>	170 Ah - maintenance-free	6 V**
6.654-124.0 <sup>3)</sup>	180 Ah - maintenance-free	6 V**
6.654-086.0 <sup>4)</sup>	180 Ah, - low maintenance	6 V**

\* Appliance requires 2 batteries

\*\* Appliance requires 4 batteries

<sup>1)</sup> Complete set (24 V/105 Ah) incl. connecting cable, order no. 4.035-373.0

<sup>2)</sup> Complete set (24 V/170 Ah) incl. connecting cable, order no. 4.035-388.0

<sup>3)</sup> Complete set (24 V/180 Ah) incl. connecting cable, order no. 4.035-387.0

<sup>4)</sup> Complete set (24 V/180 Ah) incl. connecting cable, order no. 4.035-440.0

## Insert batteries and connect

- Push the appliance forward about 2 m so that the steering rollers point toward the rear.
- Lower the cleaning head.
- Empty the fresh and waste water tank.
- Loosen the tank lock and tilt the tank upwards.
- Place the batteries in the tray close to each other towards the cleaning head and fasten them to the floor using the included holding blocks.

### ⚠ CAUTION

When the batteries are installed and removed, the stability of the appliance can be compromised; ensure a safe stance.

- Connect the connection cable to the free battery poles (+) and (-).
- Connect pole using the enclosed connecting cable.

### ATTENTION

Pay attention to correct poles.

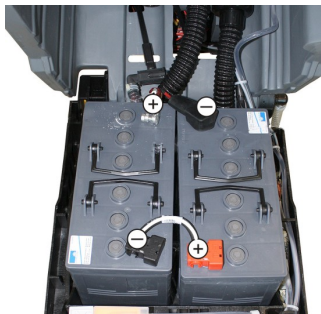

Installation sketch for 2 batteries

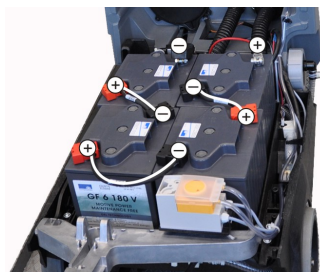

Installation sketch for 4 batteries

- Swivel the water reservoir all the way down, check the lock.

**Note:**

Charge the batteries before commissioning the appliance.

See also "Charging the batteries".

### Removing the batteries

**⚠ CAUTION**

*Risk of damage due to tipping appliance; remove batteries only if the appliance is equipped with a cleaning head.*

- Remove the Intelligent Key.
- Push the appliance forward about 2 m so that the steering rollers point toward the rear.
- Lower the cleaning head.
- Empty the fresh and waste water tank.
- Loosen the tank lock and tilt the tank upwards.
- Clamp off the minus pole of the battery.
- Clamp off the remaining cables from the battery.
- Remove the support blocks or the foam pieces.

**⚠ CAUTION**

*When the batteries are installed and removed, the stability of the appliance can be compromised; ensure a safe stance.*

- Remove the batteries.
- Dispose of the used batteries according to the local provisions.

### Maintenance contract

To ensure a reliable operation of the appliance maintenance contracts can be concluded with the competent Kärcher sales office.

### Frost protection

In case of danger of frost:

- Empty the fresh and waste water tank.
- Store the appliance in a frost-protected room.

## Faults

### ⚠ **DANGER**

*Risk of injury! Before working on the appliance, remove the Intelligent Key and the mains plug of the charger.*

- ➔ Drain and dispose of the dirt water and the residual fresh water.

### Faults with display

Display	Remedy
ERR_I_BÜRSTE_049	Check if foreign matters block the brushes; remove foreign matter if required.
ERR_I_TURB_050	Check suction turbine for contamination and clean it if necessary.
ERR_U_BATT_001	Check battery; charge it if required.

If the display shows different error messages or if the error cannot be remediated:

- ➔ Remove the Intelligent Key.
- ➔ Wait for 10 seconds.
- ➔ Plug in the Intelligent Key.
- ➔ If the fault recurs, call customer service.

### Faults without display on the console

Fault	Remedy
Appliance cannot be started	Stand-by. Turn the appliance off and reinsert the Intelligent Key. Turn the program selection switch to the desired programme.
	Check battery; charge it if required.
	Make sure that all battery terminals are connected.
Insufficient water quantity	Check fresh water level, refill tank if necessary.
	Increase the water volume on the regulating knob for water volume.
	Unscrew the lock of the fresh water reservoir. Remove and clean the fresh water filter. Insert the filter and screw in the lock.
	Remove the water distribution strip from the cleaning head and clean water canal (only R cleaning head).
Do not add detergents	Check hoses for blockages; clean if required.
	Increase the water volume to activate the dosing pump.
Insufficient vacuum performance	Check the detergent level
	Clean the seals between waste water tank and cover and check for tightness, replace if required.
	Wastewater reservoir is full; shut off the appliance and empty the wastewater reservoir
	Check protective turbine strainer for soiling, clean if necessary.
	Clean the vacuum lips on the vacuum bar, replace if required
	Check suction hose for blockages; clean if required.
	Check the suction hose for tightness; replace if required.
Check if the cover on the dirt water discharge hose is closed	
Insufficient cleaning result	Check the setting of the vacuum bar.
	Check the brushes for wear, replace if required.
Brushes do not turn	Check if foreign matters block the brushes; remove foreign matter if required.
	If over-current switch in the electronics system has been triggered, turn programme selection switch to "OFF". Afterwards, set it back to the desired programme.
Vibrations during cleaning	You might need to use softer brushes.
	Cleaning head has play, open the excenter lever and press the cleaning head all the way against the push handle, close the excenter lever.

**In case of faults that cannot be remedied using the table below please contact the customer service.**

## Accessory B 60

### BR appliances B 60 W Bp (brush roller accessories)

Description	Part no.: Working width 550 mm	Part no.: Working width 650 mm	Description	Packaging unit	Appliance requires
Brush roller, red (medium, standard)	6.906-934.0	6.906-935.0	Also for regular cleaning of heavily dirtied floors.	1	2
Brush roller, white (soft)	6.906-977.0	6.906-981.0	For polishing and cleaning sensitive floors.	1	2
Brush roller, orange (high/ low)	6.906-978.0	6.906-982.0	For scrubbing structured floors (safety tiles, etc.).	1	2
Brush roller, green (hard)	6.906-979.0	6.906-983.0	For thoroughly cleaning heavily dirtied floors and for removing the coating (for e.g. of wax, acrylate).	1	2
Brush roller, black (very hard)	6.906-980.0	6.906-984.0		1	2
Pad roller shaft	4.762-432.0	4.762-433.0	For intake of roller pads.	1	2
Roller pad, yellow (soft)	6.369-454.0	6.369-454.0	For polishing floors.	20	80 96
Roller pad, red (medium)	6.369-456.0	6.369-456.0	For cleaning slightly dirtied floors.	20	80 96
Roller pad, green (hard)	6.369-455.0	6.369-455.0	For cleaning normal to heavily dirtied floors.	20	80 96

### BD appliances B 60 W Bp (disc brush accessories)

Description	Part no.: Working width 550 mm	Part no.: Working width 650 mm	Description	Packaging unit	Appliance requires
Disk brush, natural (white)	4.905-016.0	4.905-012.0	For polishing floors.	1	1
Disk brush, white	4.905-015.0	4.905-011.0	For polishing and cleaning sensitive floors.	1	1
Disk brush, red (medium, standard)	4.905-014.0	4.905-010.0	For cleaning slightly dirtied or sensitive floors.	1	1
Disk brush, black (hard)	4.905-017.0	4.905-013.0	For cleaning heavily dirtied floors.	1	1
Driver plate pad	4.762-445.0	4.762-446.0	For intake of pads.	1	1

### BR/BD appliances B 60 W Bp (vacuum bar accessories)

Description	Part no.: Working width 850 mm	Part no.: Working width 940 mm	Description	Packaging unit	Appliance requires
Rubber lip, blue	6.273-214.0	6.273-213.0	Standard	pair	1 pair
Rubber lip, transparent, grooved	6.273-207.0	6.273-208.0	oil-resistant	pair	1 pair
Rubber lip, transparent	6.273-229.0	6.273-205.0	Non-scarring	pair	1 pair
Rubber lip, transparent	6.273-290.0	6.273-291.0	For difficult floors	pair	1 pair
Vacuum bar, straight	4.777-401.0	4.777-402.0	Standard	1	1
Vacuum bar, bent	4.777-411.0	4.777-412.0	Standard	1	1



## Technical specifications

	BR appliance B 60		BD appliance B 60		
	R 55	R 65	D 55	D 65	
<b>Power</b>					
Nominal voltage	V		24		
Battery capacity	Ah (5h)		105, 170, 180		
Average power consumption	W		2100		
Drive motor output (rated output)	W		300		
Suction engine output	W		580		
Brush engine output	W		2 x 600		
<b>Vacuuming</b>					
Vacuum power, air volume (max.)	l/s		22		
Vacuuming power, negative pressure (max.)	kPa (mbar)		16,7 (167)		
<b>Cleaning brushes</b>					
Brush speed	1/min	600 - 1300	180		
<b>Dimensions and weights</b>					
Theoretical surface cleaning performance	m <sup>2</sup> /h	3300	3900	3300	3900
Max. working range incline	%	2			
Fresh/waste water tank volume	l	60/60			
Max. water temperature	°C	60			
max. water pressure	MPa (bar)	0,5 (5)			
Net weight (transport weight)	kg	232 (with batteries 180 Ah)			
Total weight (ready to operate)	kg	292 (with batteries 180 Ah)			
<b>Values determined as per EN 60335-2-72</b>					
Total oscillation value	m/s <sup>2</sup>	0,3			
Uncertainty K	m/s <sup>2</sup>	0,2			
Sound pressure level L <sub>pA</sub>	dB(A)	70			
Uncertainty K <sub>pA</sub>	dB(A)	2			
Sound power level L <sub>WA</sub> + Uncertainty K <sub>WA</sub>	dB(A)	83			
<b>Subject to technical modifications!</b>					

### EU Declaration of Conformity

We hereby declare that the machine described below complies with the relevant basic safety and health requirements of the EU Directives, both in its basic design and construction as well as in the version put into circulation by us. This declaration shall cease to be valid if the machine is modified without our prior approval.

**Product:** Floor cleaner  
**Type:** B 60 W Bp

**Relevant EU Directives**  
2006/42/EC (+2009/127/EC)  
2014/30/EU

**Applied harmonized standards**  
EN 55014-1: 2006+A1: 2009+A2: 2011  
EN 55014-2: 2015  
EN 60335-1  
EN 60335-2-29: 2004+A2: 2010  
EN 60335-2-72  
EN 61000-3-2: 2014  
EN 61000-3-3: 2013  
EN 62233: 2008

**Applied national standards**

-

The undersigned act on behalf and under the power of attorney of the company management.

  
H. Jenner  
Chief Executive Officer

  
S. Reiser  
Head of Approbation

Authorised Documentation Representative  
S. Reiser

Alfred Kärcher GmbH Co. KG  
Alfred-Kärcher-Str. 28 - 40  
71364 Winnenden (Germany)  
Phone: +49 7195 14-0  
Fax: +49 7195 14-2212

Winnenden, 2016/06/01

### Accessories and Spare Parts

Only use original accessories and spare parts, they ensure the safe and trouble-free operation of the device.

For information about accessories and spare parts, please visit [www.kaercher.com](http://www.kaercher.com).